



**SONIC**  
THE HEDGEHOG



## THE BIRTH OF AN ICON

Sonic, the iconic blue hedgehog, came to life in 1991. Designed by Naoto Ohshima, his agile appearance and cool attitude captured the attention of players worldwide.

Blessed with unmatched speed, Sonic quickly became a video game icon, starring in a series of thrilling and exhilarating adventures.

His legacy endures as a symbol of speed, friendship, and bravery, embodying the spirit of youth and determination in every race towards victory.

## EL NACIMIENTO DEL ÍCONO

Sonic, el emblemático erizo azul, cobró vida en 1991. Diseñado por Naoto Ohshima, su apariencia ágil y su actitud fresca capturaron la atención de los jugadores de todo el mundo.

Dotado de una velocidad sin igual, Sonic se convirtió rápidamente en un ícono de los videojuegos, protagonizando una serie de aventuras emocionantes.

Su legado perdura como un símbolo de velocidad, amistad y valentía, encarnando el espíritu de la juventud y la determinación en cada carrera hacia la victoria.

## SONIC & HIS FRIENDS

For Sonic, friendship is more than a bond; it's his greatest treasure. With Tails, Knuckles, and other companions, every day is a new adventure full of challenges and emotions. Together, they face enemies, explore worlds, and celebrate victories.

Friendship not only gives Sonic strength but also teaches him valuable lessons about loyalty and camaraderie. In a universe filled with dangers, Sonic knows he can always count on his friends.

Join them on this epic journey where friendship is the key to success!

## SONIC Y SUS AMIGOS

Para Sonic, la amistad es más que un lazo; es su mayor tesoro. Con Tails, Knuckles y otros compañeros, cada día es una nueva aventura llena de desafíos y emociones. Juntos, enfrentan enemigos, exploran mundos y celebran victorias.

La amistad no solo le da fuerzas a Sonic, sino que también le enseña lecciones valiosas sobre lealtad y compañerismo. En un universo lleno de peligros, Sonic sabe que siempre puede contar con sus amigos.

¡Acompáñalos en esta épica travesía donde la amistad es la clave del éxito!



STILL UNSTOPPABLE

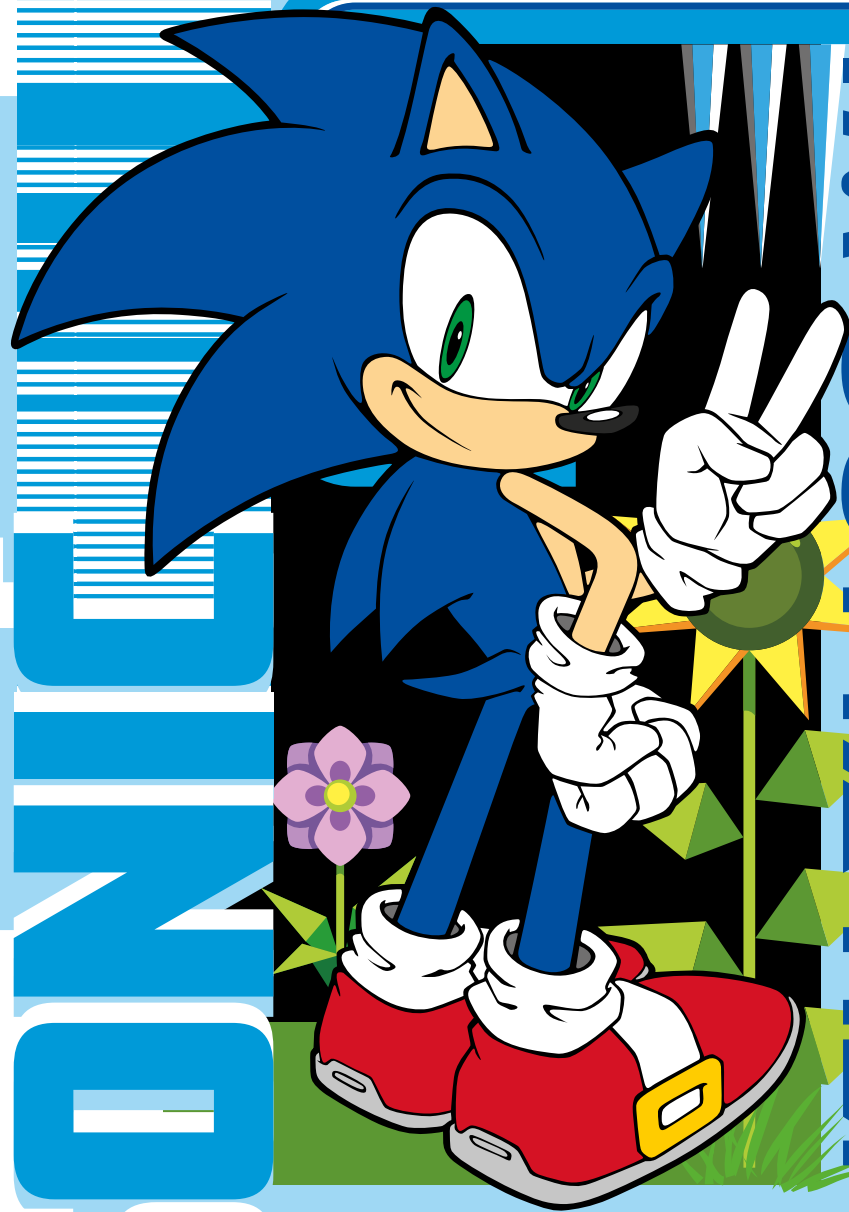

IM OUTTA HERE!



## THE LEGACY OF SONIC

Sonic has had a profound impact on childhood, shaping the way kids interact with digital entertainment.

More than just a game, Sonic fosters creativity, problem-solving, and perseverance. Through his speed-filled adventures and themes of friendship, children learn important values such as bravery and camaraderie.

Sonic has inspired generations of youth to explore, face challenges with confidence, and believe in their ability to overcome any obstacle.

## EL LEGADO DE SONIC

Sonic ha tenido un impacto profundo en la infancia, moldeando la forma en que los niños interactúan con el entretenimiento digital.

Más que solo un juego, Sonic fomenta la creatividad, la resolución de problemas y la perseverancia. A través de sus aventuras llenas de velocidad y amistad, los niños aprenden valores importantes como la valentía y la camaradería.

Sonic ha inspirado generaciones de jóvenes a explorar, afrontar desafíos con confianza y a creer en su capacidad para superar cualquier obstáculo.

## A GAMING PIONEER

The Sonic the Hedgehog games have been iconic since their debut in 1991, establishing themselves as one of the pioneers in the video game industry.

With its lightning-fast speed and memorable characters, Sonic redefined the platformer genre.

Over the years, it has remained relevant with new releases and adaptations, influencing generations of players and creators.

## EL PIONERO DE LOS VIDEJUEGOS

Los juegos de Sonic the Hedgehog han sido icónicos desde su debut en 1991, consolidándose como uno de los pioneros en la industria de los videojuegos.

Con su velocidad vertiginosa y personajes memorables, Sonic redefinió el género de plataformas.

A lo largo de los años, ha mantenido relevancia con nuevas entregas y adaptaciones, influenciando generaciones de jugadores y creadores.





## SONIC ON BIG SCREEN

The Sonic movies, featuring the iconic blue hedgehog from video games, have captivated both old and new fans.

Released in 2020 and 2022, they blend action, adventure, and comedy with impressive visual effects. Sonic has transitioned from the small screens of video games to the big screens in theaters, where he experiences thrilling adventures on Earth with his friends and the evil Dr. Robotnik, played by Jim Carrey.

These films stand out for their humor, dynamism, and nostalgia, becoming box office hits and leaving audiences eager for more.

## SONIC EN LA GRAN PANTALLA

Las películas de Sonic, el icónico erizo azul de los videojuegos, han conquistado tanto a fanáticos antiguos como a nuevos.

Estrenadas en 2020 y 2022, combinan acción, aventura y comedia con impresionantes efectos visuales. Sonic ha pasado de las pequeñas pantallas de los videojuegos a la gran pantalla en cines, donde vive emocionantes aventuras en la Tierra junto a sus amigos y el malvado Dr. Robotnik, interpretado por Jim Carrey.

Estas películas destacan por su humor, dinamismo y nostalgia, convirtiéndose en un éxito en taquilla y dejando a los espectadores ansiosos por más.

# SPINFLEX + GLOW

SPINFLEX + GLOW material: Exclusive to the brand, ultra-flexible high-resistance material that ensures child protection and minimizes breakage rates to the maximum extent possible. Additionally, the glasses have some of their components with a GLOW effect to be visible in the dark.

Material SPINFLEX + GLOW: material exclusivo de la marca, ultraflexible de alta resistencia que garantiza la protección del niño y reduce al máximo sus índices de ruptura. Además cada una de las gafas tiene algunos de sus componentes con efecto GLOW para poder verse en la oscuridad.

## REFERENCES USED:

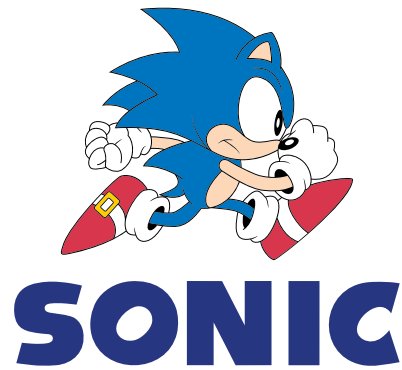
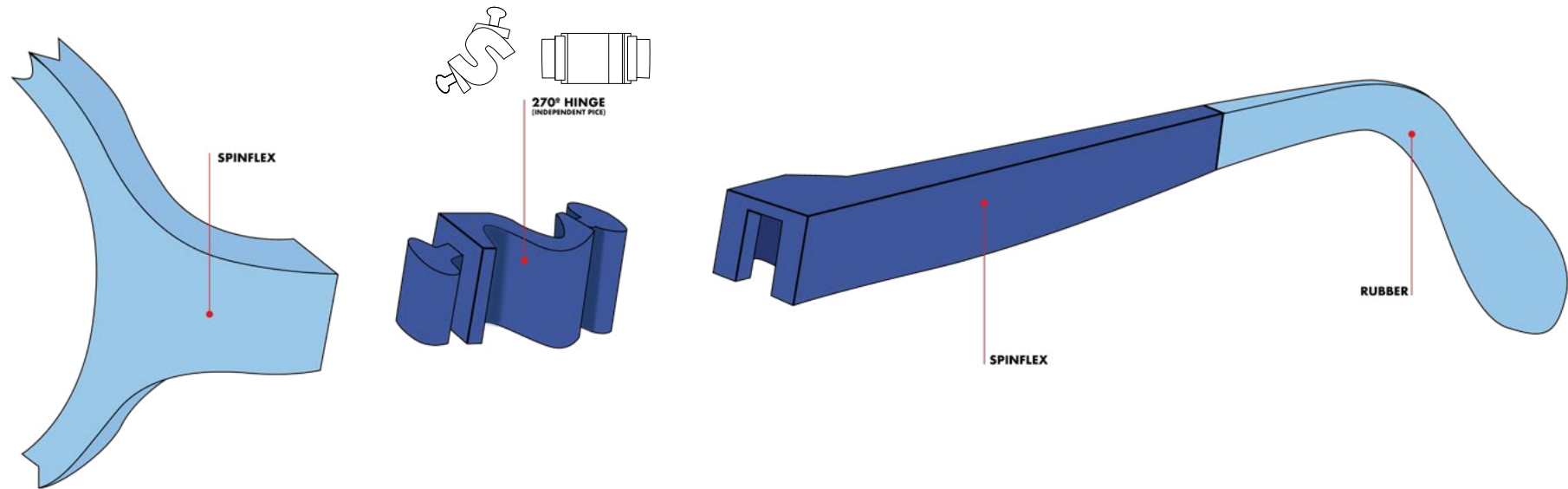
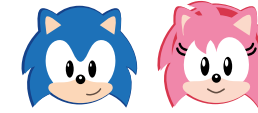

## TAIL CORD



## MATERIALS AND SPECIFICATIONS

- Injection and paint
- SPINFLEX + GLOW
- From 0 to 14 years.
- Unisex.

## ACETATE + FLEX 180°

A wide variety of colors representing SONIC and his friends.

The SONIC glasses are designed to be durable. That's why we use the 180° flex technology to prevent any breakage.

Gran variedad de colores representando a SONIC y sus amigos.

Las gafas SONIC están ideadas para ser resistentes. Por eso usamos la tecnología flex de 180° para evitar cualquier rotura.

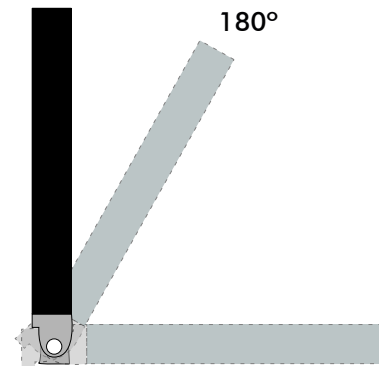
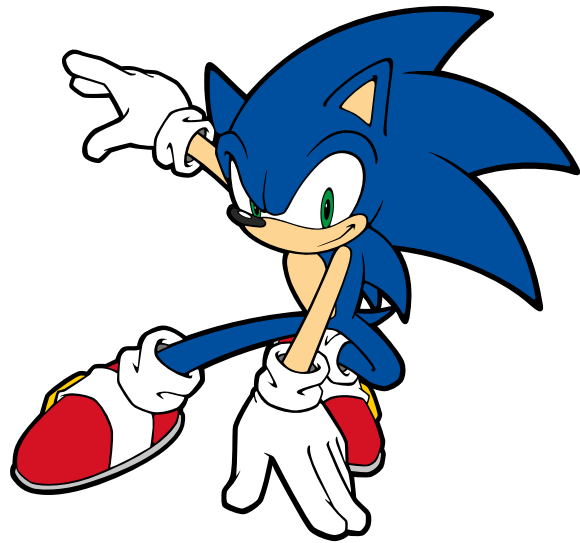

### MATERIALS AND SPECIFICATIONS

- Acetate + printing and 180° flex.
- From 6 to 14 years.
- Unisex.

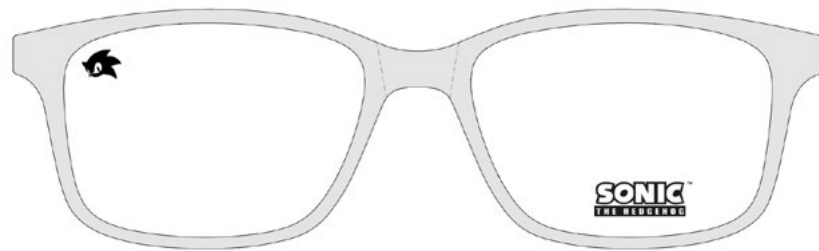

## FLEX 180° + CLIPON

The perfect combination of utility and durability.  
SONIC glasses are complemented by the Polarized  
CLIP ON and always with 180° flex technology.

La combinación perfecta entre la utilidad y la resistencia.  
Las gafas SONIC se complementan con el CLIP ON  
polarizado y siempre con la tecnología flex 180°.



### MATERIALS AND SPECIFICATIONS

- Front and Clip on in TR90 with Polarized lens and Blue Block and Temples in double injection between TR 90 and rubber.
- From 8 to 14 years.
- Unisex.

## RUBBER + ACETATE

Inspired by the colors of SONIC and his friends.

Dual injection rubber temple.

Adaptable.

Inspirado en los colores de SONIC y sus amigos.

Varilla de goma de doble inyección.

Adaptable.



## MATERIALS AND SPECIFICATIONS

- Acetate front with tripl rubber injection temples
- From 6 to 12 years
- Unisex.

## METAL + PRINTING GLOW

This collection combines Metal with GLOW effects both in the paint and in the acetates, making it unique. You will achieve absolute comfort thanks to its lightness, with an added touch of style provided by the Glow acetate.

Esta colección combina Metal con efectos GLOW tanto en la pintura como en los acetatos que la hace única. Conseguirás una comodidad absoluta gracias a su ligereza con un plus de estilo gracias al acetato Glow.



### MATERIALS AND SPECIFICATIONS

- Metal front and temple with acetate tips  
Glow colour in some details.
- Metal + printing glow.
- From 8 to 14 years.
- Unisex.

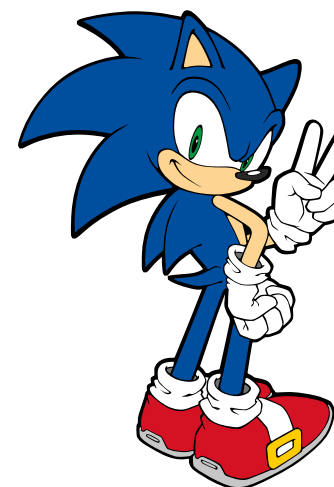

## GLOW WITH STYLE

SONIC glasses are made with the innovative **GLOW** material, designed to shine in the dark, creating a unique luminous effect. This special material absorbs light during the day and emits a subtle glow in low-light environments, adding a modern and distinctive touch. With the **GLOW** technology, your **SONIC** glasses not only enhance your style but also make you stand out.

## BRILLA CON ESTILO

Las gafas **SONIC** están fabricadas con el material **GLOW**, una innovadora tecnología que brilla en la oscuridad, creando un efecto luminoso único. Este material absorbe luz durante el día y la emite en ambientes oscuros, ofreciendo un toque moderno y distintivo. Con **GLOW**, tus gafas no solo complementan tu estilo, sino que también te hacen destacar.



**RX COLLECTION**

**SPINFLEX + GLOW**

# SO52027

SPIN FLEX + RUBBER



50



16



135



646



645



612



631



643



644

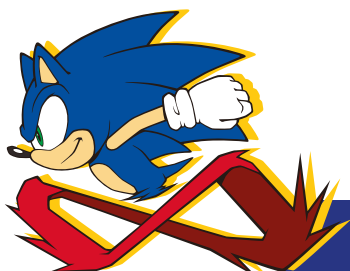

# SO52027

SPIN FLEX + RUBBER



50



16



135



546



545



512



531



543



544

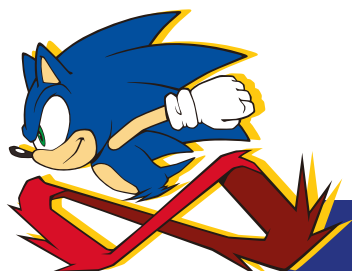

# SO52026

SPIN FLEX + RUBBER



49



15



135



646



645



612



633



643



644

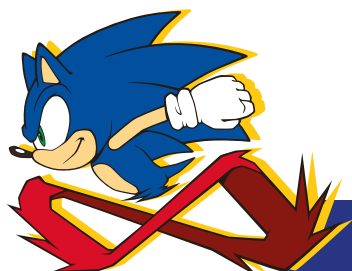

# SO52026

SPIN FLEX + RUBBER



49



15



135



546



545



512



533



543



544

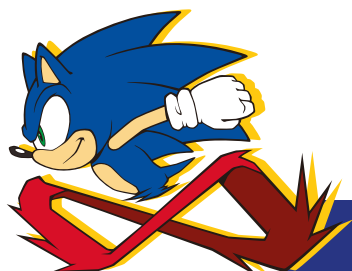

# SO52025

SPIN FLEX + RUBBER



47



14



135



646



645



612



633



641



643

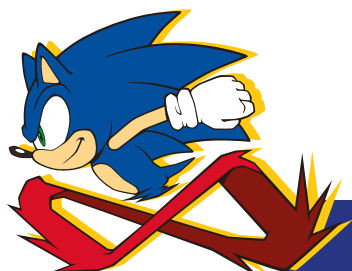

# SO52025

SPIN FLEX + RUBBER



47



14



135



546



545



512



533



541



543

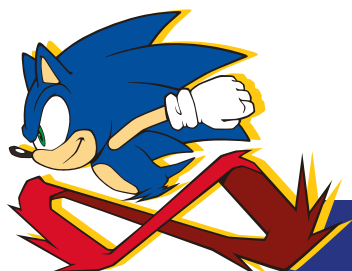

# SO52024

SPIN FLEX + RUBBER



46



15



135



675



646



612



631



643



644

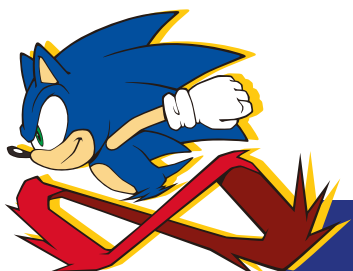

# SO52024

SPIN FLEX + RUBBER



46



15



135

575



546



512



531



543



544

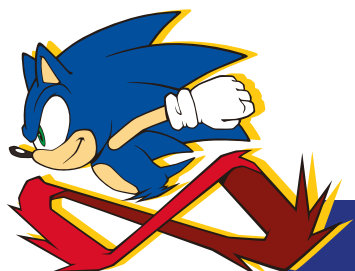

# SO52023

SPIN FLEX + RUBBER



44



14



130



675



664



641



643



644



645

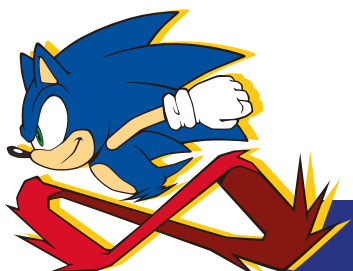

# SO52023

SPIN FLEX + RUBBER



44



14



130



575



564



541



543



544



545

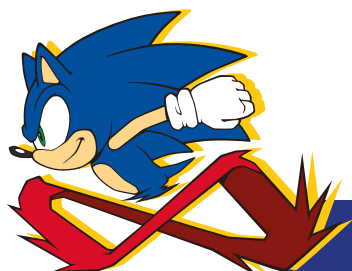

# SO52022

SPIN FLEX + RUBBER



49



14



135



562



556



512



513



553



555

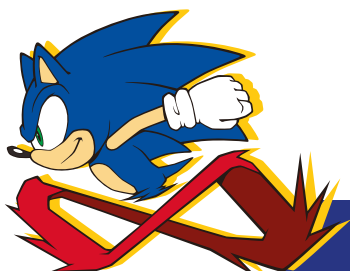

# SO52022

SPIN FLEX + RUBBER



49



14



135



662



656



612



613



653



655

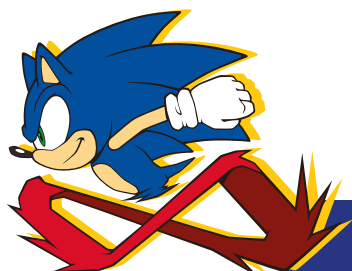

# SO52021

SPIN FLEX + RUBBER



47



15



135

586



565



553



555



556



562

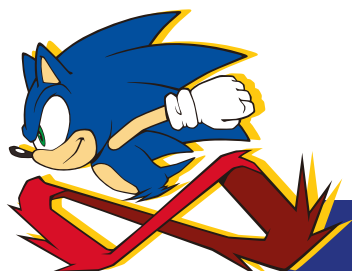

# SO52021

SPIN FLEX + RUBBER



47



15



135

686



665



653



655



656



662

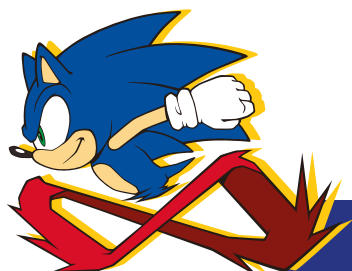

# SO52020

SPIN FLEX + RUBBER



45



17



135

664



662



636



653



654



655

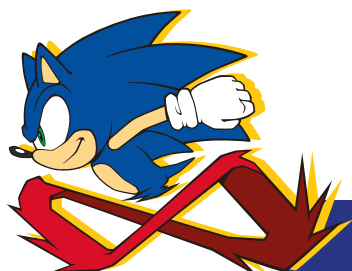

# SO52020

SPIN FLEX + RUBBER



45



17



135



564



562



536



553



554



555

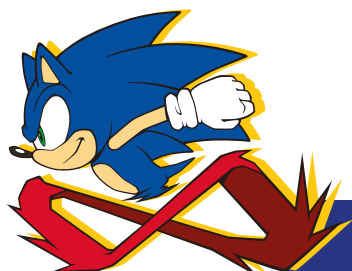

# SO52019

SPIN FLEX + RUBBER



45



14



130

686



665



654



655



656



662

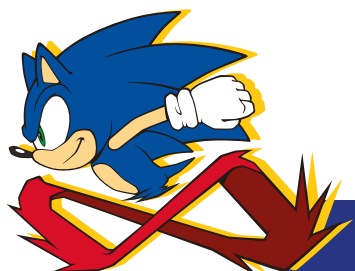

# SO52019

SPIN FLEX + RUBBER



45



14



130

586



565



554



555



556



562

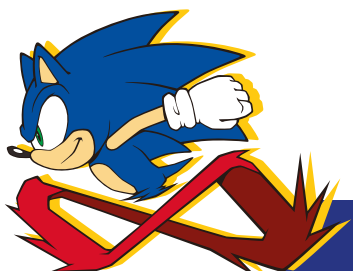

# SO52018

SPIN FLEX + RUBBER



44



14



130

665



663



637



653



655



662

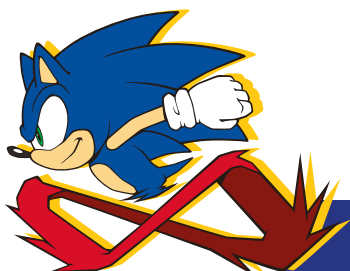

# SO52018

SPIN FLEX + RUBBER



44



14



130



565



563



537



553



555



562

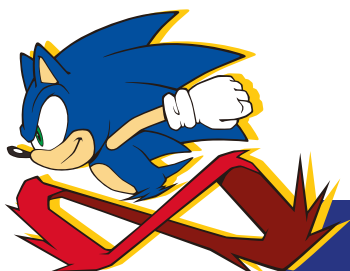

# SO52017

SPIN FLEX + RUBBER



43



16



115

657



666

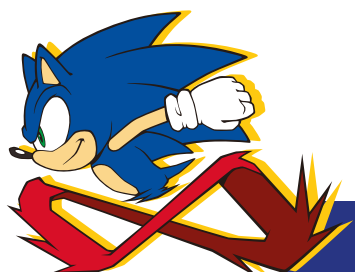

# SO52017

SPIN FLEX + RUBBER



43



16



115

647



641



541



547



557



566

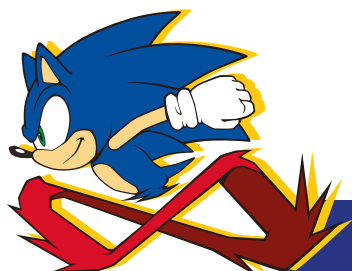

# SO52016

SPIN FLEX + RUBBER



41



16



115

667



677

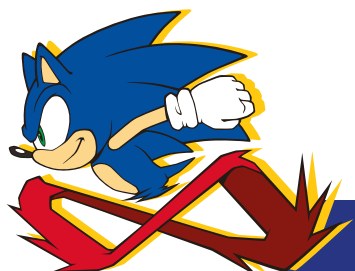

# SO52016

SPIN FLEX + RUBBER



41



16



115

647



637



537



547



567



577

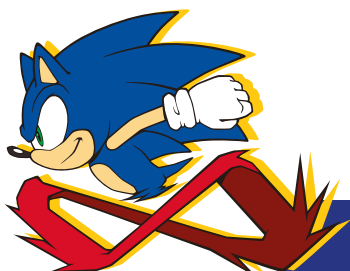

**METAL + GLOW**

# SO52047

METAL + ACETATE



49



15



130

203



212



243



244

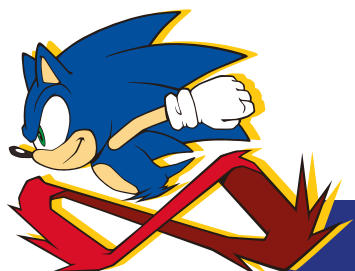

# SO52046

METAL + ACETATE



47



17



135

102



103



212



243

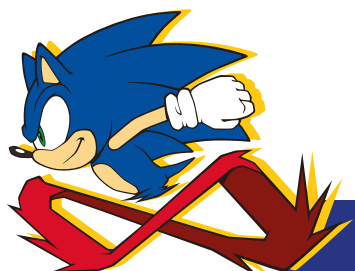

# SO52045

METAL + ACETATE



48



17



135



102



212



243



244

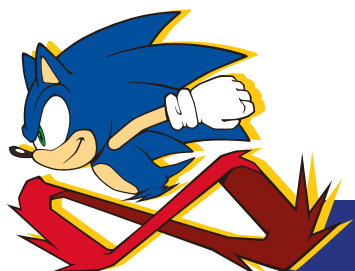

# SO52044

METAL + ACETATE



49



18



135



100



101



221



265

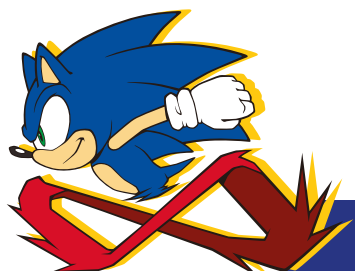

# SO52043

METAL + ACETATE



47



16



130



100



101



256



262

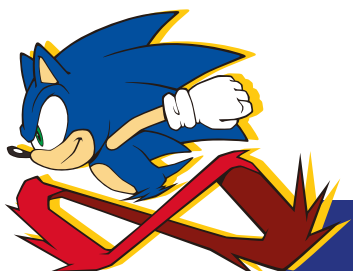

# SO52042

METAL + ACETATE



47



19



130

100



101



235



265

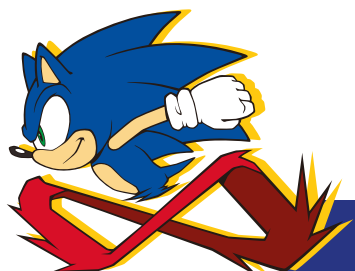

# SO52015

METAL + ACETATE



49



17



135

212



233



241



243

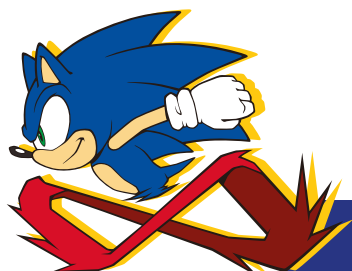

# SO52014

METAL + ACETATE



47



17



135

212



245



246



275

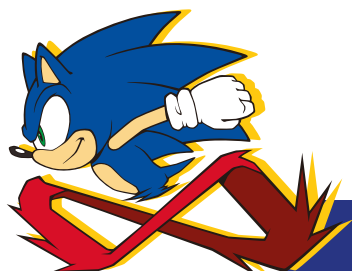

**RUBBER + ACETATE**

# SO52008

RUBBER



45



15



130

511



550



555



565

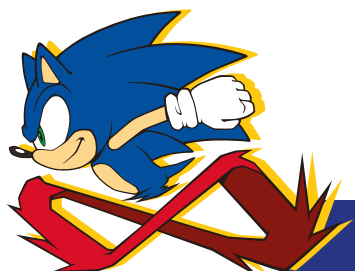

# SO52005

RUBBER



45



14



130

511



535



543



545

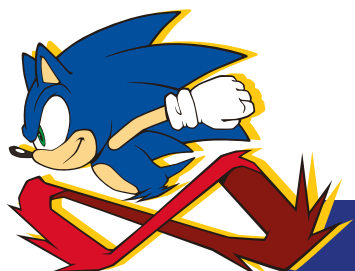

**ACETATE + FLEX 180°**

# SO52076

ACETATE



48



16



135



512



516



541



544



545

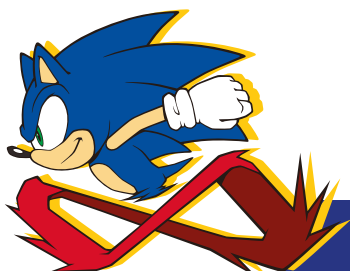

# SO52077

ACETATE



51



15



135



512



516



541



544



545

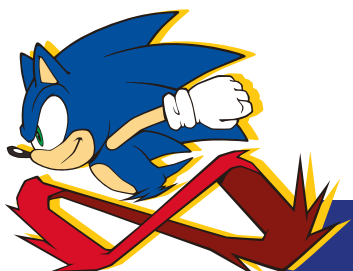

# SO52075

ACETATE



49



15



135



512



516



535



540



544

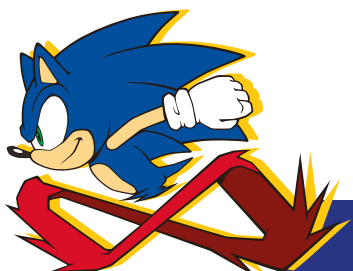

# SO52074

ACETATE



50



17



130



535



540



544



596



612

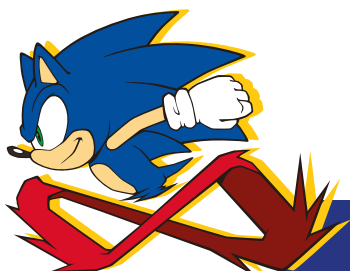

# SO52073

ACETATE



47



15



130



512



515



534



544



545

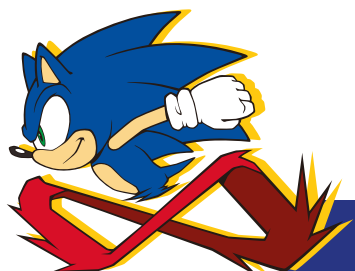

# SO52072

ACETATE



47



15



130



548



550



560



565



599

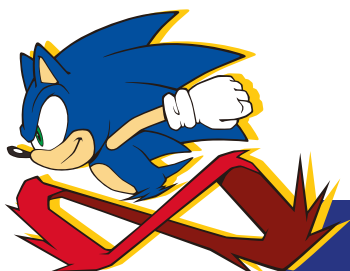

# SO52071

ACETATE



46



16



130



550



555



560



562



566

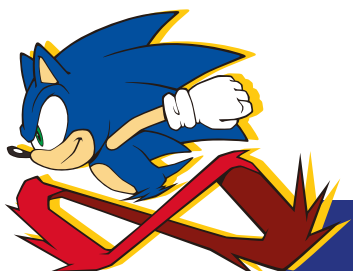

# SO52070

ACETATE



50



15



130



512



540



550



560



562

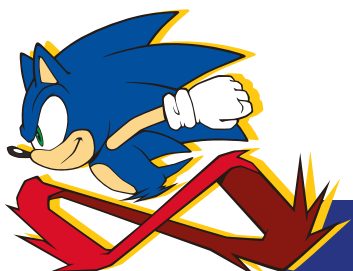

# SO52069

ACETATE



47



17



130



512



514



531



541



544

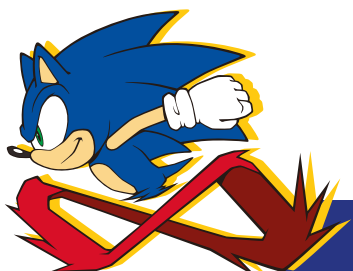

# SO52067

ACETATE



45



17



125



511



516



541



544



545

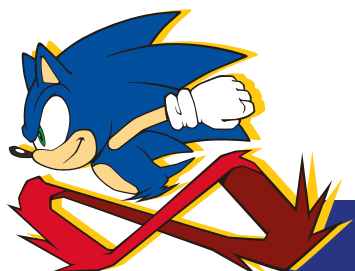

# SO52065

ACETATE



46



17



130



511



535



541



545



546

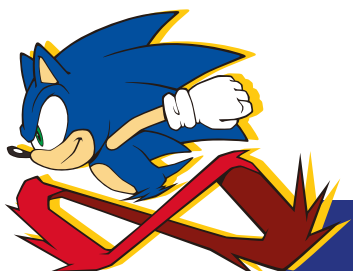

# SO52063

ACETATE



48



16



130

512



514



534



541



545

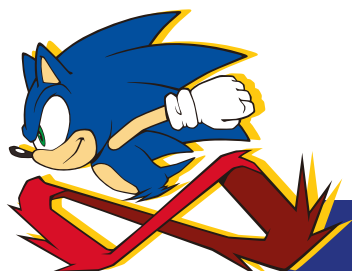

# SO52062

ACETATE



46



17



130



545



558



565



566



599

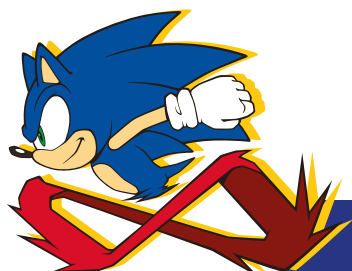

# SO52060

ACETATE



45



16



125



546



550



562



566



599

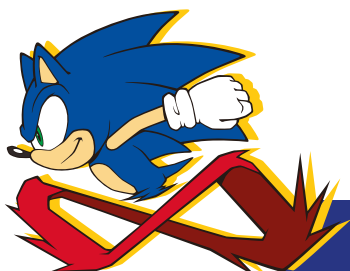

# SO52059

ACETATE



45



15



125

511



535



541



545

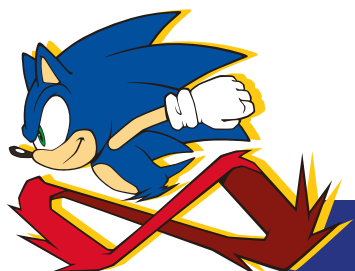

# SO52058

ACETATE



51



15



135



515



612



541



544



545

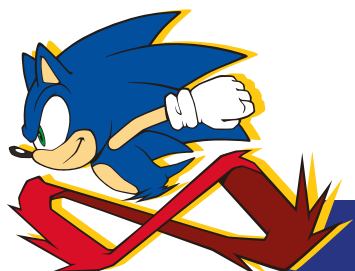

# SO52057

ACETATE



48



17



135

511



645



512



541



544

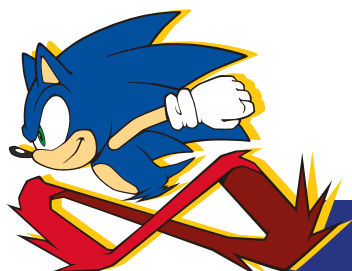

# SO52056

ACETATE



50



17



135



612



512



514



535



545

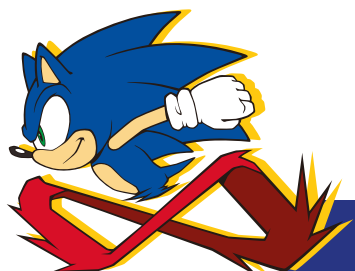

# SO52055

ACETATE



47



17



130



545



534



536



541



543

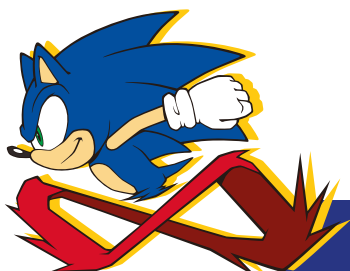

# SO52054

ACETATE



49



16



135

511



575



545



556



565

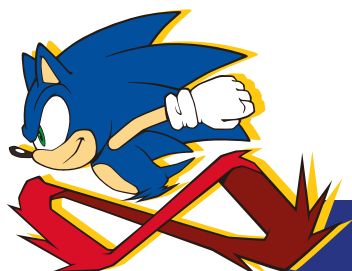

# SO52053

ACETATE



44



16



130

531



568



564



565



567

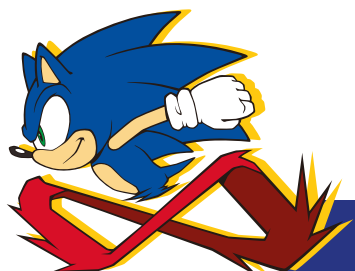

# SO52052

ACETATE



48



15



135



555



566



556



562



565

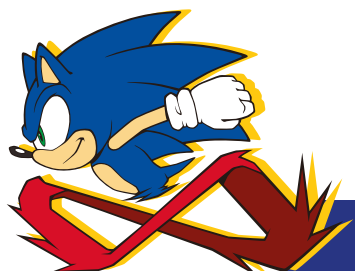

# SO52051

ACETATE



47



16



135

530



599



550



554



575

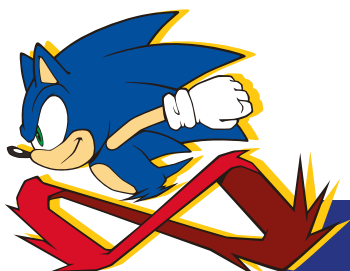

# SO52050

ACETATE



43



15



120



575



535



541



542



545

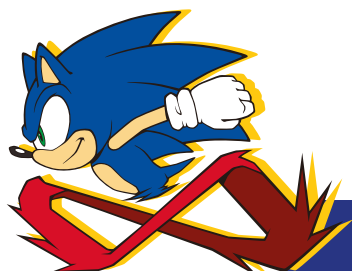

# SO52049

ACETATE



44



17



125



575



511



541



542



545

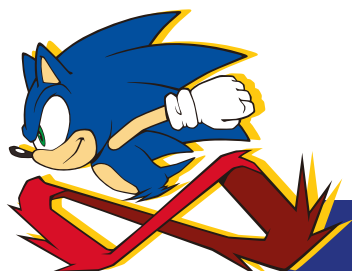

# SO52048

ACETATE



47



17



135



565



560



535



543



545



557

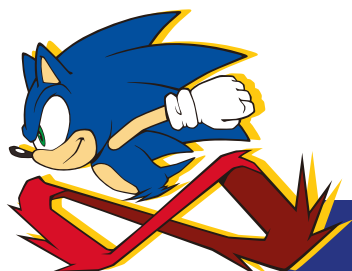

# SO52041

ACETATE



47



16



135

545



599



555



565



598



# SO52039

ACETATE



46



17



130



644



545



511



512



535



544

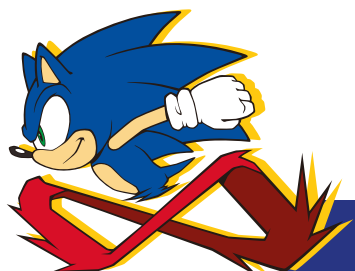

# SO52038

ACETATE



43



15



120



644



575



511



535



541



545

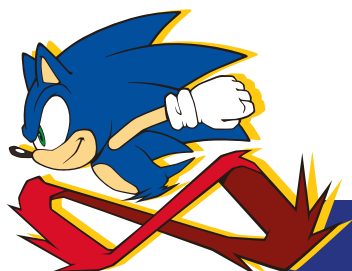

# SO52037

ACETATE



46



17



130



566



565



511



535



541



555

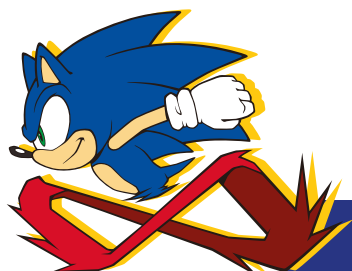

# SO52036

ACETATE



43



18



120



575



566



537



545



555



565

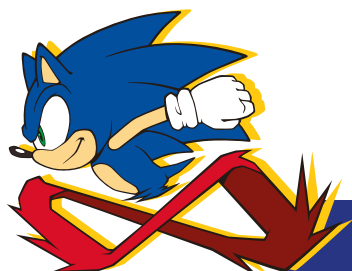

# SO52035

ACETATE



44



17



125



575



548



511



512



525



545

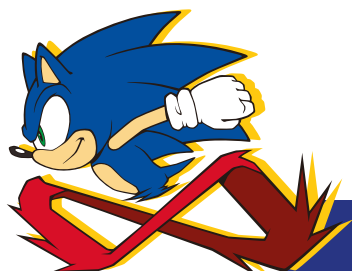

# SO52034

ACETATE



44



17



125



575



546



512



543



544



545

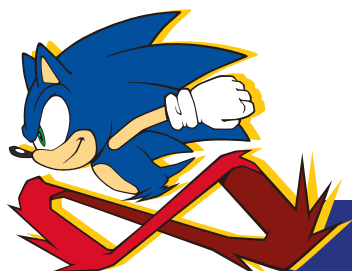

# SO52032

ACETATE



48



17



130



612



545



511



541

543

544

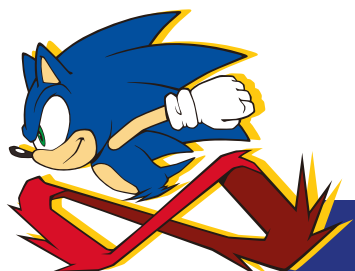

# SO52032

ACETATE



643



48



17



130

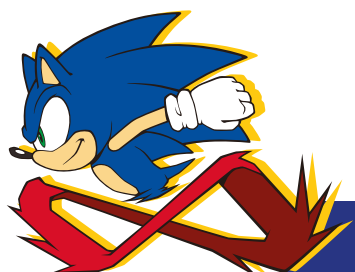

# SO52031

ACETATE



46



17



125



575



545



511



512



535



544

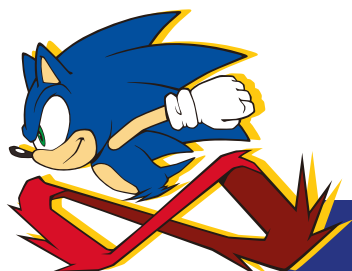

# SO52029

ACETATE



45



16



125



644



575



511



541



542



545

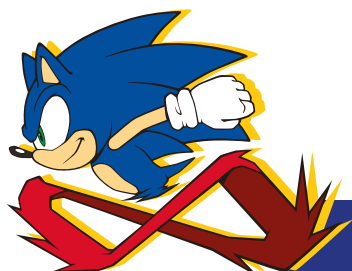

# SO52028

ACETATE



45



15



125

575



558



512



535



545



546

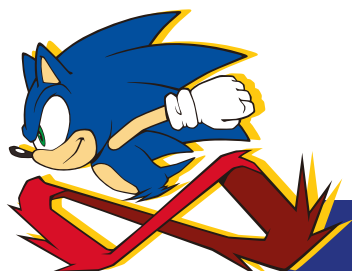

**FLEX + CLIP ON**

# SO20006

TR90+RUBBER



47



18



130



612



675



643



641



633

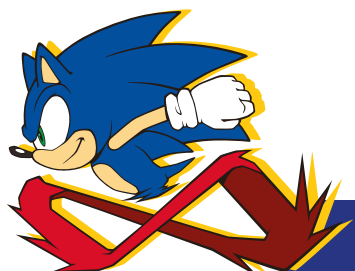

# SO20005

TR90+RUBBER



50



15



130

643



612



641



613



614



633

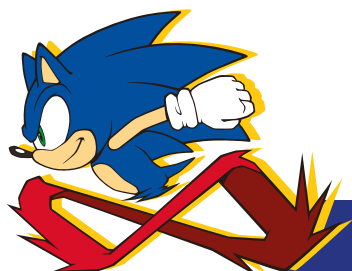

# SO20005

TR90+RUBBER



50



15



130

644



645

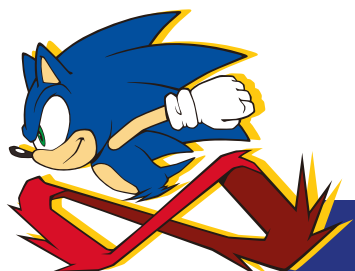

# SO20004

TR90+RUBBER



51



17



130

613



633



675



644



643



641

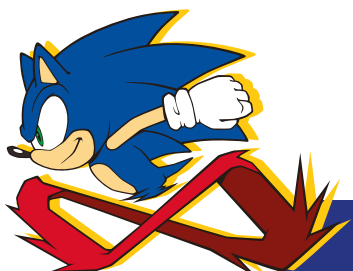

# SO20004

TR90+RUBBER



51



17



130

612



543

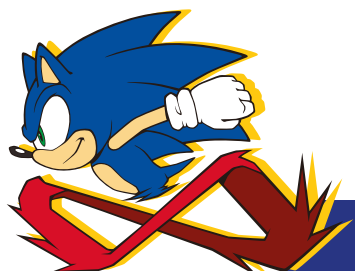

# SO20003

TR90+RUBBER



48



17



135

649



654



653



665



662



655

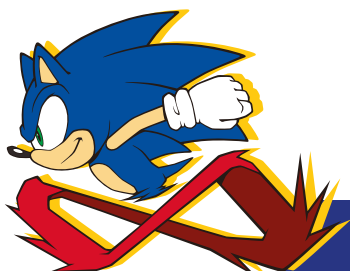

# SO20003

TR90+RUBBER



48



17



135

553



645

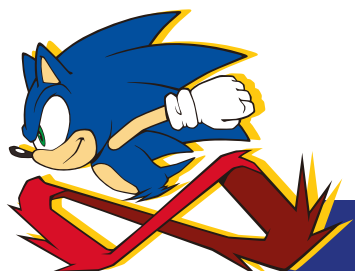

# SO20002

TR90+RUBBER



46



17



130

649



653



565



665



656



655

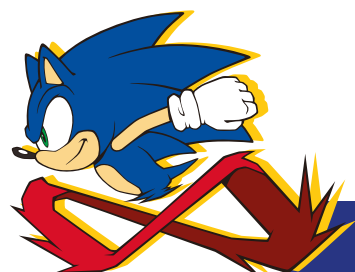

# SO20002

TR90+RUBBER



46



17



130

648



566

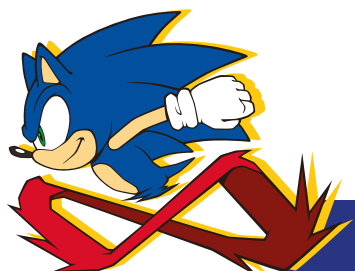

# SO20001

TR90+RUBBER



46



17



135

653



655



644



535



633



643



# SO20001

TR90+RUBBER



46



17



135

662



675

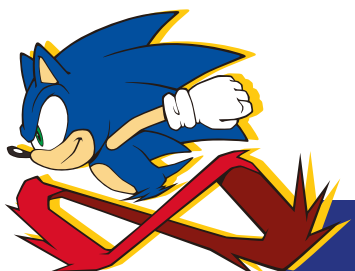

# SO20000

TR90+RUBBER



46



15



130



645



644



643



633



642



575

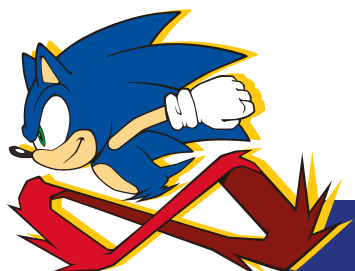

# SO20000

TR90+RUBBER



46



15



130

675



541

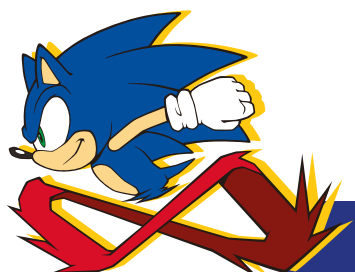

**POINT OF SALES**

1



2



3



4



- 1. SHOWCARD 15x21 cm  
Ref. **PSO0032**
- 2. SHOWCARD 29x40 cm  
Ref. **PSO0033**
- 3. SHOWCARD 29x40 cm  
Ref. **PSO0034**
- 4. SHOWCARD 29x40 cm  
Ref. **PSO0035**

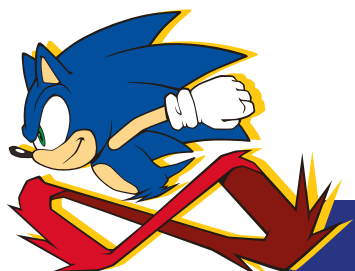

1



2



3



4



- 1. SHOWCARD 29x40 cm  
Ref. **PSO0036**
- 2. SHOWCARD 29x40 cm  
Ref. **PSO0037**
- 3. SHOWCARD 20x30 cm  
Ref. **PSO0038**
- 4. SHOWCARD 20x30 cm  
Ref. **PSO0039**

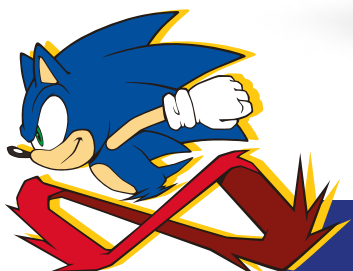

1



2



3



4



5



- 1. SHOWCARD 15x21 cm  
Ref. **PSO0020**
- 2. SHOWCARD 29x40 cm  
Ref. **PSO0021**
- 3. SHOWCARD 29x40 cm  
Ref. **PSO0022**
- 4. SHOWCARD 29x40 cm  
Ref. **PSO0023**
- 5. SHOWCARD 20x29 cm  
Ref. **PSO0024**

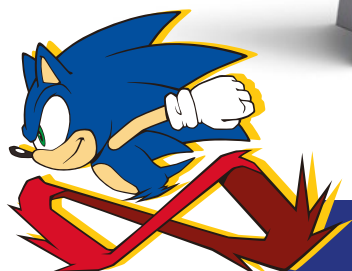

6



7



6. SHOWCARD 15x21 cm

Ref. **PSO0025**

7. SHOWCARD 29x40 cm

Ref. **PSO0026**

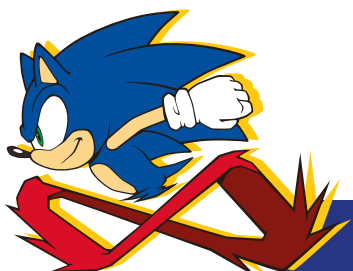

8

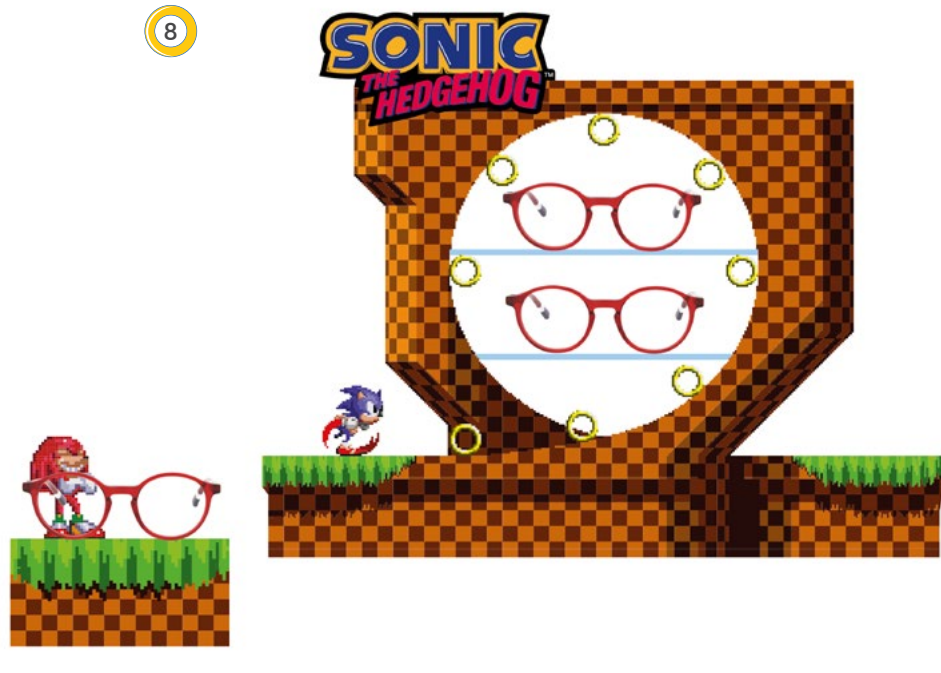

9



8. POSTER 70x100 cm

Ref. **PSO0019**

9. EXHIBITOR

Ref. **PSO0029**



1



2



3



4



5



1. SHOWCARD 15x21 cm  
Ref. **PSO0005**
2. SHOWCARD 29x40 cm  
Ref. **PSO0006**
3. SHOWCARD 29x40 cm  
Ref. **PSO0007**
4. SHOWCARD 20x29 cm  
Ref. **PSO0008**
5. SHOWCARD 29x40 cm  
Ref. **PSO0009**

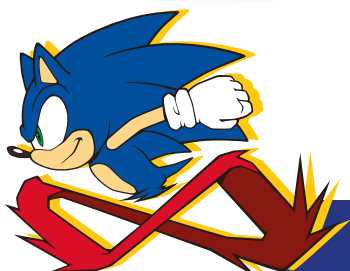

1



2



3



4



- 1. SHOWCARD 29x40 cm  
Ref. **PSO0010**
- 2. SHOWCARD 29x20 cm  
Ref. **PSO0011**
- 3. POSTER 70x100 cm  
Ref. **PSO0004**
- 4. EXHIBITOR  
Ref. **PSO0003**

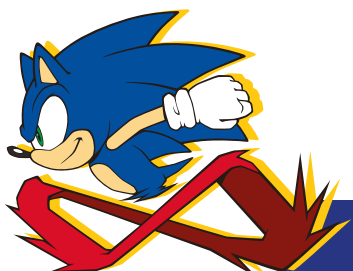

1



2

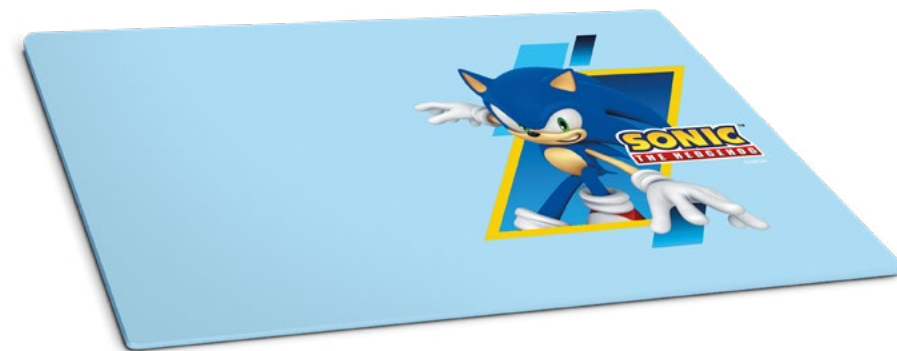

- 1. MIRROR  
Ref. **PSO0001**
- 2. TABLEPAD  
Ref. **PSO0002**

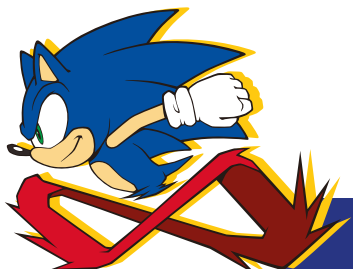

1



2



3



- 1. CLASSIC COLLECTION CASE  
Ref. **ESTSO24A**
- 2. MODERN COLLECTION CASE  
Ref. **ESTSO24N**
- 3. CLIPON CASE  
Ref. **ESTSO24CL**

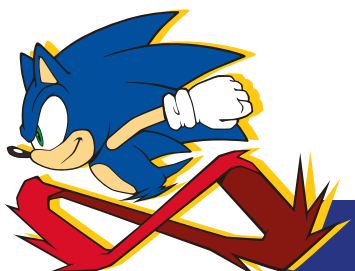



C/ Espigolera 13, 08960 Sant Just Desvern, Barcelona - SPAIN  
**T +34 934 809 393 · info@optim.vision · www.optim.vision**

 @modaoptica    optimvision    @optim.vision